



Owner's Manual EN

**DEM UPGRADE HEAD UNIT FOR
2014+ HARLEY DAVIDSON® MOTORCYCLES**



SOUNDSTREAM
TECHNOLOGIES

Bluetooth

X300
WATT
4CH. AMPLIFIER



HDHU.14+

Contents

Safety First	
Safety Definitions	2
Pre-Riding	
Checklist	3
Care and cleaning	3
Screen	3
Appearance	3
Accessories & Installation	4
Installation	5
Panel Description	6
Wiring	7
Harness	8
Operation	
Main menu	9
Setting	9
Apple CarPlay®/Android Auto®	12
Radio operation	13
USB operation	13
Bluetooth Music	14
Bluetooth Phone	15
Specification	17
Troubleshooting	18
FCC Notes	19

Safety First

Safety Definitions

Statements in this manual preceded by the following words are of particular significance:

▲WARNING

WARNING indicates a potentially hazardous situation that could result in death or severe injury if not avoided.

▲WARNING

Set volume levels and other controls on audio and electronic devices before riding. Distractions can lead to loss of control, resulting in death or serious injury.

▲WARNING

Do not select a volume level that blocks out traffic noise or interrupts the concentration necessary for the safe operation of the Motorcycle. Distractions or a volume level that blocks our traffic noise could cause loss of control resulting in death or severe injury.

Note

Pay attention while riding, keeping your eyes and clear mind on the road. Some features are locked out to prevent distraction, limited in capability while the Motorcycle is in motion. Even a part is available, donot allow it to distract you from operating your Motorcycle safely.

For safety, program the system when stopped. Perform system setup and get familiar with the controls and features of the infotainment system before operating the Motorcycle on the road.

This system cannot warn about the safety of an area, bad road conditions, and availability of emergency services.

Use this radio only in locations where it is safe to do.

Before You Ride....

Checklist

Configure the system with your personal preferences before riding to use features and minimize distractions while on the road entirely.

1. Set brightness, background.
2. Configure presets.
3. Adjust audio settings like EQ, volume, fade, balance etc. before riding.
4. Pair, connect and set up phone features through Bluetooth.
5. Connect USB devices for Apple CarPlay® or Android Auto®.
6. Select station or media.

CARE AND CLEANING

Use only **HDHU.14+** recommended products and methods to keep the radio, speakers, and other audio system components clean and in good condition.

Do not use any abrasives, polishes, or rubbing compounds to clean the screen or other components. Do not use any ammonia-based cleaners on the net. The use of other products or methods may cause damage to components.

Screen:

Do not use any chemical cleaners or chemical-containing wipes or cloths. These can cause damage to the screen surface.

Gently clean the display glass surface with a clean, dry microfiber cloth. Before cleaning, it is suggested to remove any visible dust, dirt, sand particles with a gentle compressed air stream.

Appearance

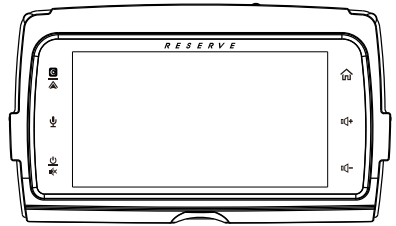

Front

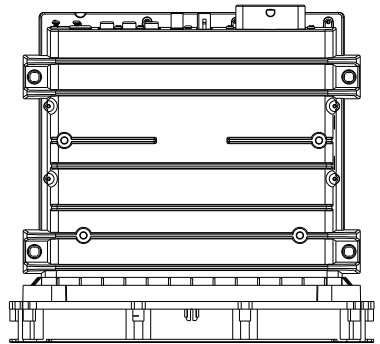

Top

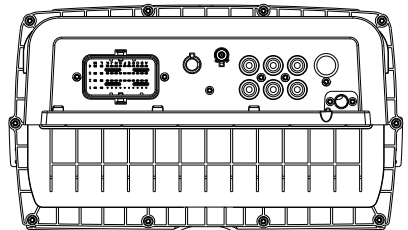

Back

Accessories and Installation

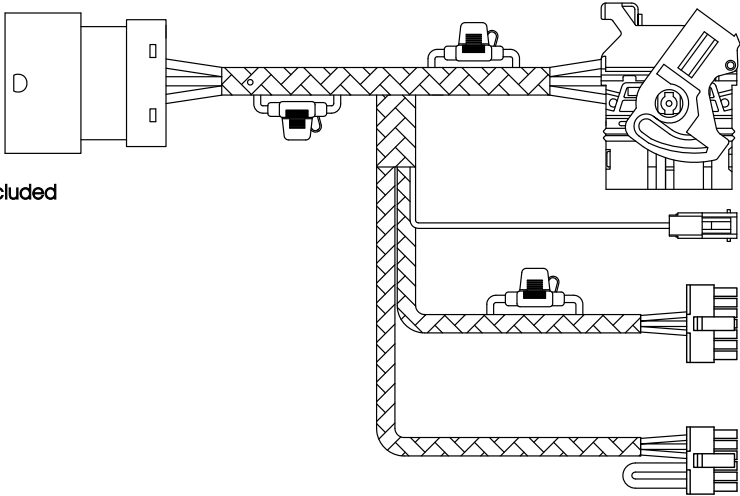

Harness Included

Installation

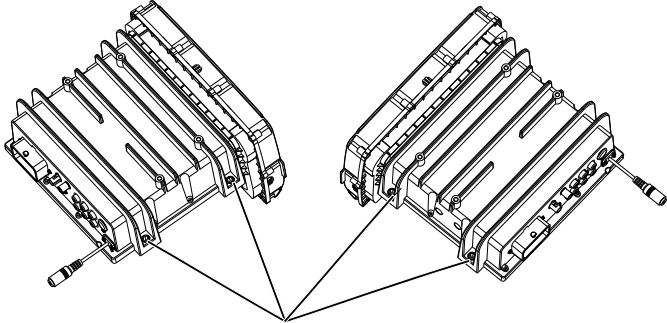

Use OEM head unit mounting locations & original screws

Installation

Note: Reinstall the OEM bracket after head unit installation

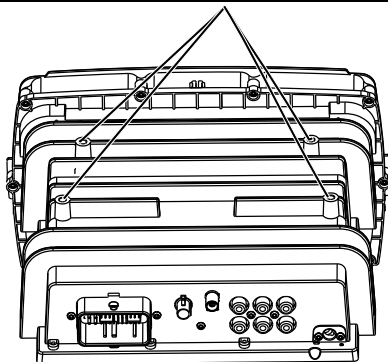

Installation

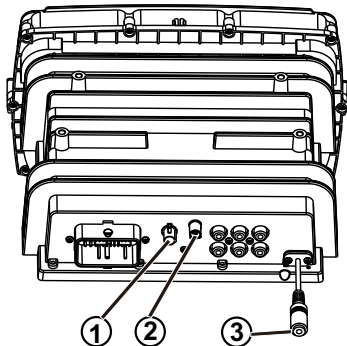

- 1 USB Fakra Connector**
Connect the OEM USB cable to the USB connector for playback Android smartphone, iPhone
- 2 AM/FM Radio Connector**
Connect the Radio Antenna from HD Motorcycle.
- 3 External Microphone Connector**
Connect the External Microphone.
(Used for Voice Command Function)

Panel Description

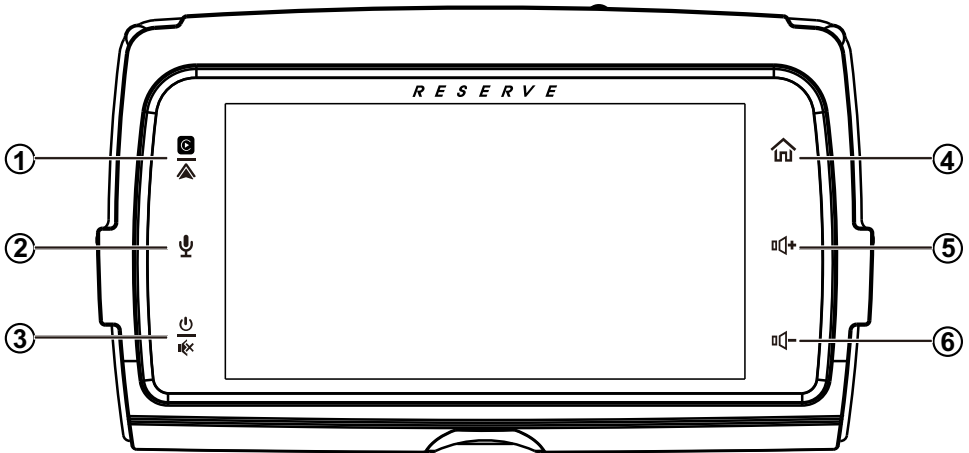

1 Apple CarPlay® / Android Auto®

Press to enter CarPlay® / Android Auto® directly (When the iPhone/Android phone is connected).

2 SIRI Button Voice Recognition

Press to enter CarPlay® / Android Auto® directly

(When the iPhone/Android phone is connected).

3 Power / Mute

- When the power is off, press to power on.
- When the unit is working, short pressing for Mute, press again for unmute.
- Pressing and hold to turn the source unit power off.

4 Home button

- Press to toggle between the home screen and active media.
- Available selections: Radio, Apple CarPlay® / Android Auto®, BT Music, BT Phone, USB, Settings.

5 Volume + (Volume +)

- Press to increase the volume value.

6 Volume - (Volume -)

- Press to decrease the volume value.

Wiring

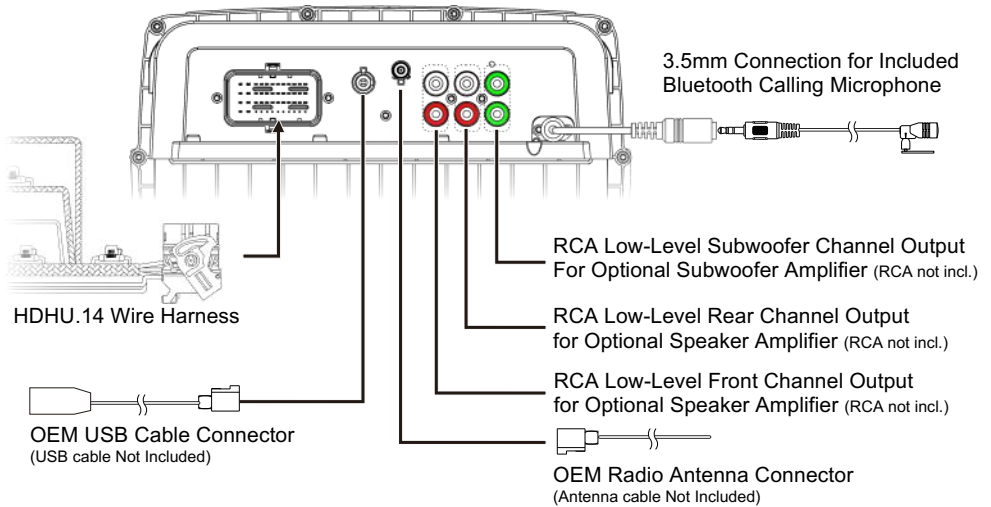

Included Harness

Harness : Connect to Motorcycle:

Connect to HDHU.14+ (Headunit):

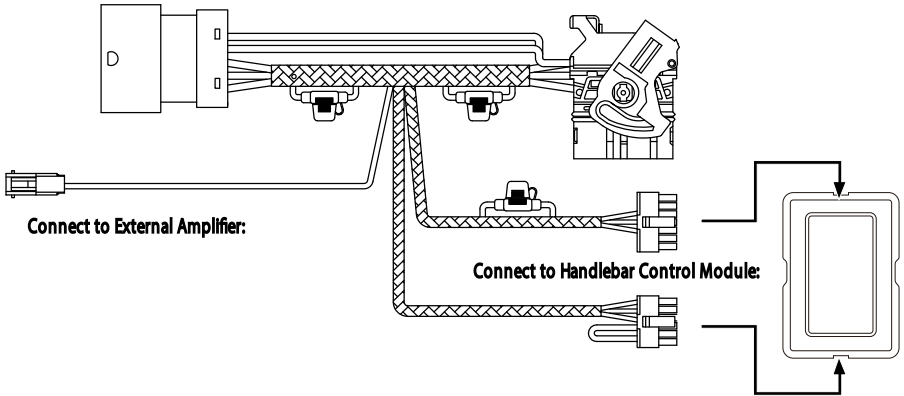

Connect to External Amplifier:

Connect to Handlebar Control Module:

Note: The Handlebar Control Module is Not Included

Main Menu



HDHU.14+ is a headunit for Motorcycle with the following functions:

Apple CarPlay®, Android Auto®, Radio, USB, BT Music, Phone.

Touch the corresponding Mode icon to enter playing mode. The Mode icon in gray means the corresponding function is not ready, or the proper device has not been connected.



Hidden soft button bar:

A hidden pop-up soft button bar is located at the bottom. Touch the icon  to show the soft button bar. Touch the  to hidden.



Dimming, to change Daylight or Night (If illumination detect is OFF in Display Setting)



Setup to enter the Settings Menu.



Bluetooth pairing.



EQ, to enter the Equalizer setting menu.

Settings

Touch the  icon to enter the Setup menu. The Setup menu is included System Settings, Display Settings, Audio & EQ Settings, Bluetooth Settings.

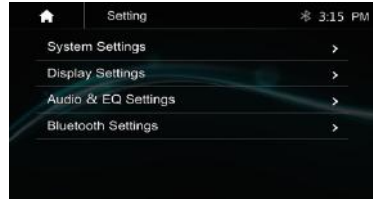

System Settings :

The System Settings allow the user to set up the Language, Date & Time, Key Beep, Factory Reset, and About



Language :



Date & Time:

To setting Time display format (12H or 24H), setting the date and time

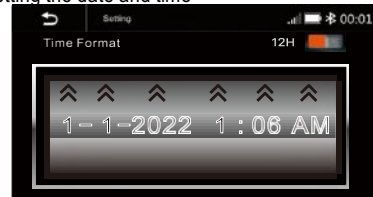

Settings

Beep Tone: On / Off

To set the touch button beep tone is On or Off.

Factory Setting:

To default the default factory settings:



About:

To display the HDHU.14+ hardware and firmware version.



Display setting:

Below is the Display setting menu; users can select Lighting Detect, Daylight Dimming Level, Night Dimming Level, Illumination, and Wallpaper.



Lighting Detect: On/Off

Daylight Dimming Level: 8 – 15

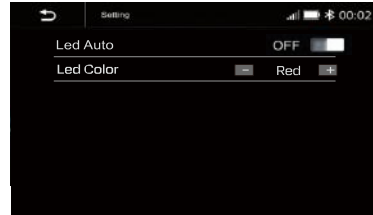

Night Dimming Level: 0 – 8

Illumination



Led Auto: On/Off.

ON: The Led color will change automatically.

OFF: You press the button  or  select desired color.

Color: White / Red / Yellow /Blue / Green / Purple / Light Green

Wallpaper:

Users can select the preset wallpaper or select preferred pictures in the USB driver as the wallpaper.



Touch the corresponding picture to select the preferred background.

Touch "+", "the head unit will search the USB photo file for wallpaper. Select a picture and touch OK to add the wallpaper.

 Select another picture for replacing the current wallpaper.

Settings

Audio & EQ Setting

Below shown is the Audio settings menu.



Balance/Fader:

Touch the + or – of Balance/Fade to tune for the driver and passenger preference.

The value of Balance (Left 12 – Right 12) and Fade (Front 12 – Rear 12)

Touch Reset to set both Balance and Fade to zero



Subwoofer Output: On/Off

Subwoofer Filter: 50Hz, 80Hz,120Hz,160Hz

Subwoofer Level: -10 ~ +10

10- Band Equalizer:

10 - band of EQ tuning, slide the EQ bar to tune each band frequency level according to user preference.

Touch Reset button to sell all Band to zero.

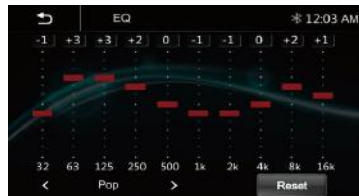

Or user can touch "<" or ">" at the bottom to select the following preset EQ:
Off, Soft Rock, Pop, Electric, Jazz, EQ Custom.

Bluetooth Settings :

Touch the Bluetooth Settings from the setting menu will be shown below:



Connection: On/Off (Select Bluetooth connections On or Off).

Pairing: To start the pairing.



Device Name: Shown the connected Phone or device name.

Clear Records: To clear the device list records.

Apple CarPlay® & Android Auto®

Apple CarPlay®:

Plug the iPhone (iPhone 5 or later models, and IOS 7.1 or above) through the lightning cable to the USB port of the source unit. The iPhone will be shown the "CarPlay." The source unit will enter the CarPlay interface, the APP that supports the CarPlay feature will be displayed on the source unit. Touch the corresponding APP can operate.

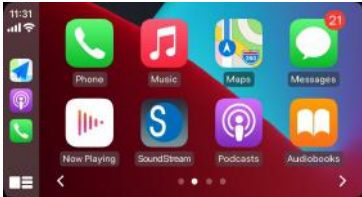

Siri:

In CarPlay® mode, the user can talk to SIRI to Control the CarPlay® functions. Press  to start the SIRI function, touch the button for 2 seconds or the iPhone's HOME button. Now you can talk to Siri about

playing music; I am going...

Note: For the SIRI function in the source unit, the

The microphone must be connected.

In CarPlay® mode, touch the "Home" button or

 icon to go back to the main Menu of the source unit.

Android Auto®:

Android Auto® enables you to use functions of your Android device convenient for driving. You can easily access route guidance, make calls, listen to music, etc. For details about

Android Auto®, visit

<https://www.android.com/auto>

or <https://support.google.com/androidauto>

Compatible Android devices

You can use Android Auto with Android devices of Android version 5.0 or later.

Note: Android Auto may not be available on all devices and is unavailable in all countries or regions.

Operation:

1. Connect an Android device via a USB terminal. To use the hands-free function, connect the Android device via Bluetooth. When an Android device compatible with Android Auto is connected to a USB terminal, the device is connected via Bluetooth automatically, and the Bluetooth smartphone currently connected is disconnected.

2. Unlock your Android device

3. To enter Android Auto mode, touch the Android Auto icon on the head unit screen. You can perform the operations of the Apps of the connected Android device.

4. In the Android Auto model, touch "Home" to the head unit main menu.

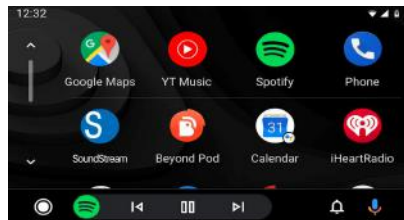

Radio

Touch "Radio" in the main Menu to enter the radio interface.



Touch "FM" can change between FM1>FM2>FM3.



Touch "AM" can change between AM1>AM2.



Touch for pre-scan search; each scan station will be played for 3sec, and touch again to stop.



Touch to auto-scan searching.



Touch to enter EQ settings.



Touch to switch Local or DX.



Touch to enter Radio settings.



Short touch to seek down, long touch to tune down.



Short touch to seek up, long touch to tune-up.

Preset channel, six preset buttons store, and recall stations for each band. Touch and slide the preset channel can switch to the next band, FM1/FM2/FM3 or AM1/AM2.

Store a Station

1. Tune the radio to the desired station.
2. Touch and hold one of the preset stations for more than 3 seconds, then the preset button will be highlighted on the screen, and the preset station will be stored.

USB

Radio setting:



Radio Area: Select the region, American/Europe /Eastern Europe /Japan /Southeast Asia /Latin American/ Asia / Australia.

RDS: Switch ON or OFF.

TA: Switch ON or OFF. **AF:**

Switch ON or OFF. **PTY:**

Switch ON or OFF.

Note: AF is only for the European region.

USB

Plug the USB; the USB icon will be colorful. Touch the USB icon to enter the USB playback mode. The source unit will playback the audio in the USB device.



Press to go to the following folder.





Press to search Audio files. Press





to go to the previous folder.

USB

 Short press to skip previous track. Long press to fast reverse.

 Play or Pause button.

 Short press to skip the next track. Long press to fast forward.

 Press to select Repeat All> Repeat 1> Repeat Folder.

 Press to switch Random is On or Off.

 Press to select Audio setting or set the preferred EQ of each band in custom mode.

File List Browsing

Touch  to browse the folder and file list of the USB device.

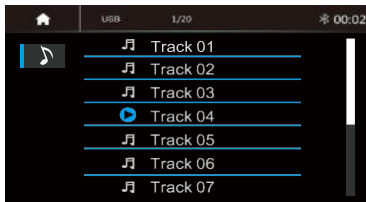

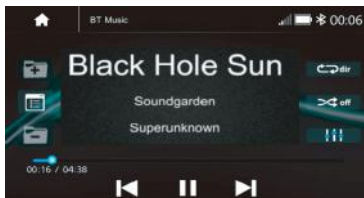

Bluetooth Music:

Touch the BT Music icon to enter Bluetooth Music playing mode. If the Bluetooth is connected, the music will be playing as below shown:





Bluetooth

 Press to search Audio files.

 Short press to skip previous track. Long press to fast reverse.

 Play or Pause button.

 Short press to skip the next track. Long press to fast forward. Press to select Repeat All> Repeat 1> Repeat Folder.

 Press to switch Random is On or Off.

 Press to select Audio setting or set the preferred EQ of each band in custom mode.

Bluetooth Connect:

If the Bluetooth is not connected, press Reconnect the paired Phone or pairing to pair the new device.

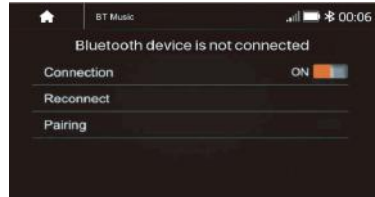

Bluetooth Pairing:

The pairing screen will be shown as below:



Turn on the Bluetooth of the Mobile phone/ Bluetooth device; you can see the "SOUNDSTREAM HD." Select the "SOUNDSTREAM HD" for pairing and connection.

Bluetooth Phone

Bluetooth Phone:

After the mobile Phone is connected with the source unit via Bluetooth(HFP), the user can go through the source unit

Make a phone call. Touch the Phone icon in Main Menu to go to BT Phone mode. Please note it needs to connect the microphone for phone calls.



Keypad. Tap it to enter call mode.



History. Tap it to show the call record, missed, received, and dialed calls.



Contact. Tap it to show the phonebook of connected device.



BT Setup. Tap it to set Auto answer and Microphone gain.







Make a call or accept the incoming call.



Backspace, tap it to clear the incorrect dial digit.

Make a Call:

1. Touch the  icon to enter the dial screen.
2. Touch 0-9, *, #, #, use the keypad, and enter the desired number to dial. If you input an incorrect number, touch the  icon on the keypad to delete the wrong number.
3. Once the correct number appears on the screen, touch the  icon to go to the dialing interface.
4. To end the call, touch the icon  on the screen.



Receive an incoming call:

If the Phone is connected with the source unit via Bluetooth, when an incoming call, the below screen will be shown:

Press  to answer the incoming call.

Press  to reject the incoming call.

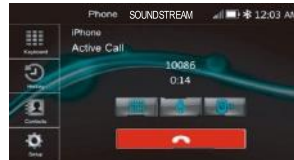

The interchange between phone and source unit.



Toggle On / Off the Microphone function.



Display the Keypad.

Bluetooth Phone

Call List:

Touch the  icon to display the call combined list.

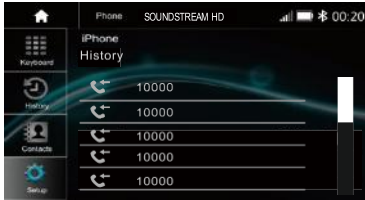

Slide the bar at the right up and down to display call logs.

Contacts:

Touch the  icon to access the phone book of the connected mobile Phone. To make a call from the phonebook, simply touch the contact's name.



BT Setup:



Auto Answer: On/Off, incoming call auto answer.

MIC Gain: Low /Middle /High

HDHU.14+ Specifications

GENERAL

Power Requirement:	DC 10 - 16Volts,
Power Requirement:	Negative ground
Current Drain:	15A (Max.)
Maximum Power Output:	50Watts x 4
RMS Power Output:	25Watts x 4
Speaker Impedance:	2- or 4-Ohm Load
Frequency Response:	20Hz ~20KHz
Operating temperature:	-20~60 °C
Dimensions:	230mm(W) x 210mm(D)x 140mm(H)

TFT Display

TFT Screen size:	7 – Inch TFT/LCD
Resolution	1024 x 600 pixels

FM RADIO SECTION

Frequency Range	87.5 – 107.9 MHz (America) 87.5 – 108 MHz (Europe)
Usable Sensitivity (S/N=30dB)	≤ 15dB
S/N Ratio:	≥ 55dB
Stereo Separation	≥ 30dB

AM RADIO SECTION

Frequency Range	(America) 522 – 1620 kHz (Europe) 530 – 1710 kHz
Usable Sensitivity (S/N=20dB)	≤ 40dB
S/N Ratio:	≥ 45dB

Line-out / Subwoofer Output

Maximum Output Level (10K ohms load):	≥ 4V RMS
Subwoofer Time Align	0~18ms

Trouble Shooting

Problem	Cause	Correct action
No Power, Dead.	Check Fuse	Replace Fuse
	Incorrect Wiring	Consult your Local Specialist. www.MotorcycleAudio.com/Specialist-Locator
No sound output when operating the unit with amplifiers or power antenna attached.	Power antenna lead is shorted to ground excessive current is required or remote on the amplifiers or power antenna	<ol style="list-style-type: none"> 1. Turn off the unit. 2. Remove all wires attached to the power antenna lead. Check each wire for a possible short to the ground using an ohm meter. 3. Turn on the unit. 4. Reconnect each amplifier remote wire to the power antenna lead one by one. If the amplifiers turn off before all wires are attached, use an external relay to provide remote-on voltage (excessive current required).
Poor performance of radio station	Weak signal	Move the Motorcycle to another place, then try again
No Sound or Audio	Volume is in minimum The wiring is not properly connected.	Adjust volume to the desired level. Check wiring connection

FCC Notes

WARNING! NOTE: This equipment has been tested and found to comply with the limits for a **ClassB** digital device, pursuant to **Part 15 of the FCC Rules**. These limits are designed to provide reasonable protection against harmful interference in a residential installation. Changes or modifications to this unit not expressly approved by the party responsible for compliance could void the user's authority to operate the equipment.

This equipment generates, uses, and can radiate radio frequency energy and, if not installed and used in accordance with the instructions, may cause harmful interference to radio communications.

Suppose this equipment does cause harmful interference to radio or television reception, which can be determined by turning the equipment off and on. However, there is no guarantee that interference will not occur in a particular installation. In that case, the user is encouraged to try to correct the interference by one or more of the following measures:

- Reorient or relocate the receiving antenna.
- Increase the separation between the equipment and receiver.
- Connect the equipment into an outlet on a circuit different from that the receiver is connected.

www.MotorcycleAudio.com

Follow Us on Social Media

